

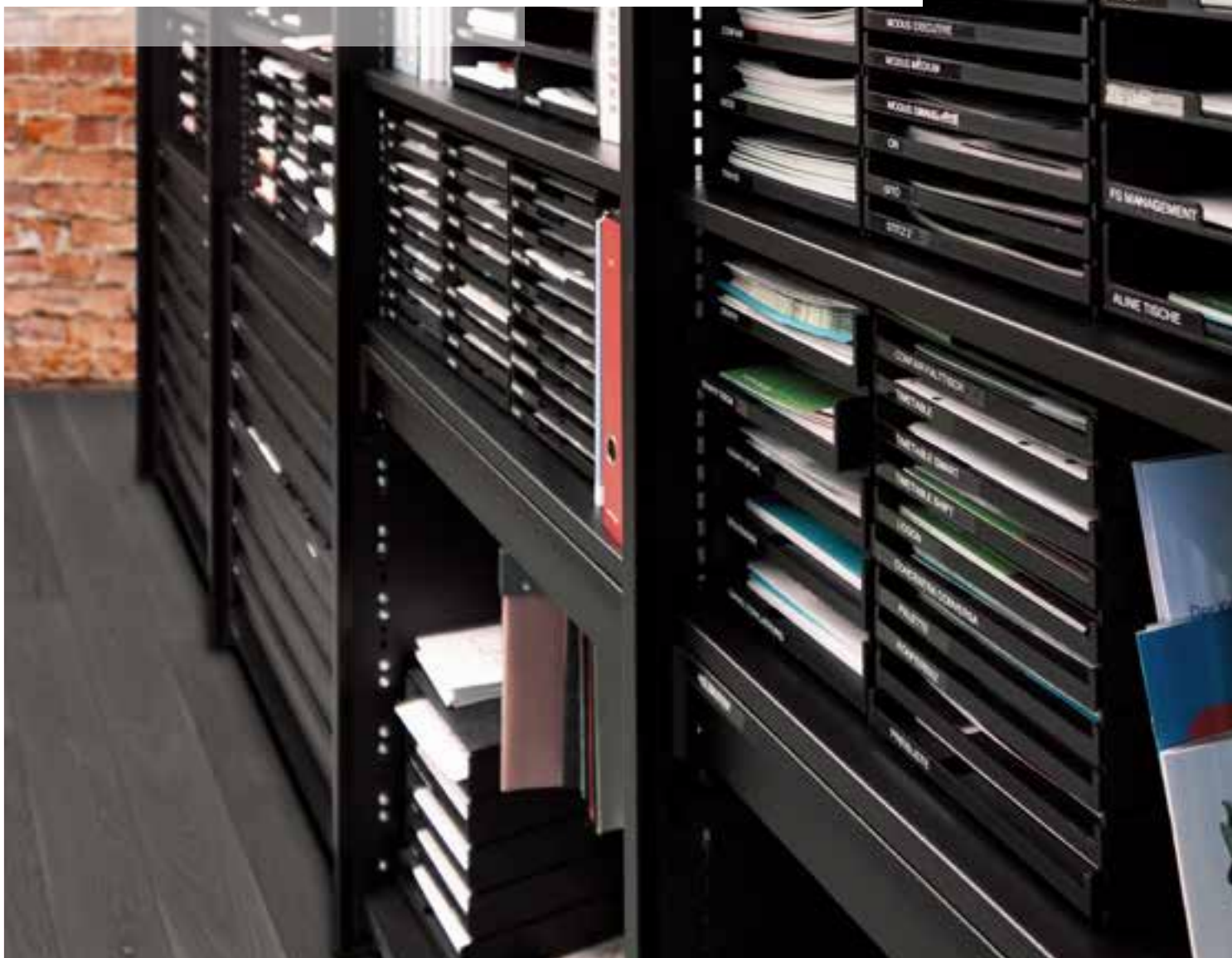

LISTA UNIVERSAL SHELVING

THE IDEAL OFFICE SOLUTION



L1006 universal shelving

The impressive feature of the universal shelving system from LISTA is that it is fully modular. Available in two versions – either with shelf supports or with open sides – and a variety of heights, depths and unit widths, the slot-in system is quick and easy to assemble for a wide range of requirements. Individual configuration options with shelves, partitions, drawer units and more produce an orderly, space-saving storage system in which everything is ready to hand. Whether small parts, bulk goods, tools or archive material: the LISTA universal shelving system is the ideal warehouse solution – especially in the lean area.



! ALWAYS WITH LISTA

Choice of colours

12 standard colours, all other colours available; see Compact, p. 12. Many shelving systems are also available in a galvanised version.

Intelligent locking systems

Replaceable cylinders which can be adapted to existing locking systems, electronic numeric and remote locking systems via RFID Lock for absolute security made to measure; see Compact, p. 13.

Individual configuration options

in size, equipment, locking system, colour and drawer partitions; see Compact, p. 10.

Fully combinable

Standardised dimensions for all LISTA universal shelving systems of varying designs; see Compact, p. 11.



+ Utmost stability

Sturdy shelf supports or side panels with a load capacity from 1,000 kg to 2,800 kg per shelving unit

+ High load capacities

80 kg to 400 kg per shelf

+ Generous storage capacity in a small space

Can also be installed as a double-stack set-up on request

+ Fast and easy assembly

Non-screwed, slot-together design of all basic components and shelves simplifies assembly

+ Flexible configuration options

Drawers, clothes rails, organisation rails, pull-out suspension file frames, shelf front cover strips, drip trays, grating covers, etc.

+ Fully modular

Standardised dimensions for all LISTA universal shelving units and customisable configuration options. The layouts of the shelf supports and side panels can be combined

+ Can be adapted to new storage items at any time

Flexible integration and rearrangement of shelves, drawers and individual parts in increments of 25 mm

+ Secure locking

Choice of hinged doors or space-saving sliding doors in combination with rear panels

+ Ideally suited to lean environments

Perforated rear and side panel covers and sloping shelves for fast, ergonomic access to tools and materials

+ Maximum shelf use

Shelves have an edging height of only 25 mm so that the full storage height is available

L1006 universal shelving

+ Fully modular and available in a wide range of versions

All individual parts and accessories of the universal shelving system can be freely positioned and combined with one another in a modular fashion – and this applies to both equipment versions (with shelf supports or with side panel).

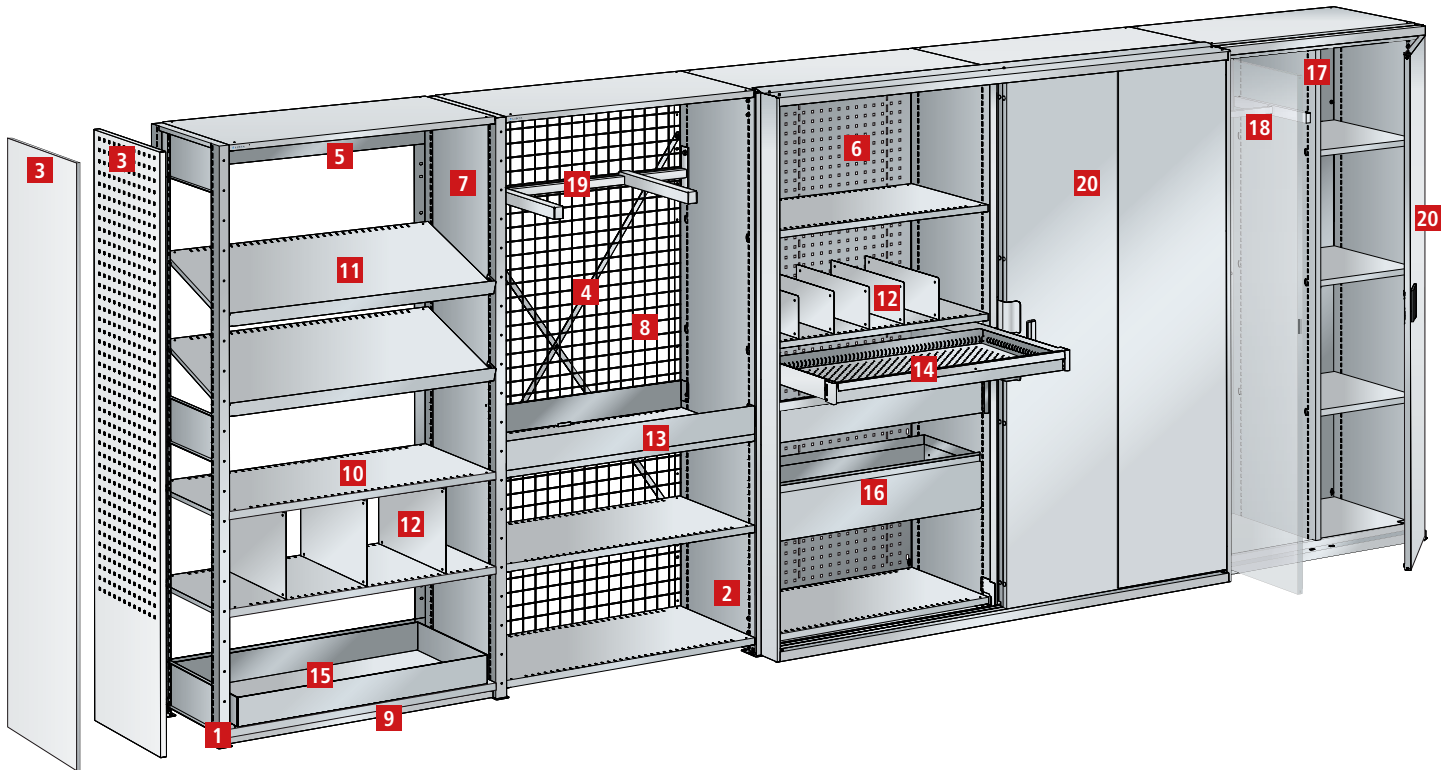

➤ Dimensions and load capacities, see page 182.

1 Shelf supports

Sturdy, open layout with a maximum load per unit of 2,800 kg, optional extension unit for shelving heights up to 5 m.

2 Side panel

Elegant closed layout with a maximum load per unit of 1,000 kg also prevents the stored items from falling out

3 Side panel cover, plain or perforated

For covering the open shelf supports or the row of slots on the side panels, perforated version for tool hooks

4 Diagonal brace

For stabilising the shelving units lengthwise

5 Lengthwise braces

Used instead of diagonal braces to make both sides accessible

6 Rear panel, plain or perforated

For covering the rear panel of shelving units; also stabilises the units lengthwise, perforated version for tool hooks

7 Partition

Placed between the shelf supports

8 Grating

Can be used as side panel covers, rear panels and partitions, prevents access and yet guarantees visibility and ventilation

9 Base cover

Protects against dust and dirt. Also prevents items from sliding underneath the unit

10 Shelf

High compartment loads of 80 to 400 kg (edge height 25 mm) for maximum use of space, in a choice of plain or slotted

11 Sloping shelf LEAN

Retrofittable stop bars for fitting shelves at an incline, for providing ergonomic access to materials and parts

12 Partitions and shelf dividers

For subdividing slotted shelves, ideal for storing small parts and small boxes

13 Shelf front cover strip

For the neat and tidy storage of bulk goods

14 Drawer

Fully extendable with load capacity of 50 kg for space-saving storage of small parts; extensive range of partition material

15 Drip tray

For storing liquids and for use as a drip tray

16 Pull-out suspension filing frame

Suitable for A4 suspension files; load capacity 50 kg for the orderly storage of and easy access to suspension files

17 Centre partition

For the vertical subdivision of complete shelf units

18 Clothes rail

Perfect for storing clothing and protective workwear

19 Organising rail

For vertical storage, compartment division and for storing ring-shaped materials (cables, vee belts and tubing)

20 Hinged and sliding doors

Secure access and dust protection with hinged doors or space-saving sliding doors, lockable



L1006 universal shelving



L1006 universal shelf unit for the office

- Elegant, closed side panel
- Pull-out suspension filing frame for orderly, easily accessible suspension files
- Partitions for orderly storage of and easy access to files and folders
- Shelves with an edging height of only 25 mm so that the full height of a file is available

! **NEW!**
Shelf heights 1,100mm,
1,450 mm and 1,800 mm for 3,
4 or 5 file heights



Configure and order L1006 universal shelving individually

Shelf unit floor area

- Choice of shelf dimensions W × D (e.g.: 1000 × 500 mm)
- To calculate the external dimension, please refer to the planning instructions on p. 8/9

1. Layout and shelving height

- Choice of «shelf supports» or «side panel» layout – combinations are possible!
- Choice of shelving height H
- Optional: shelf support cover, extension units, side panel covers and partitions, floor anchoring, levelling plates

2. Stabilising elements

- Choice of stabilising elements: diagonal braces, rear panels or lengthwise braces

+ Your individual choice of colour on request

Benefits

LISTA is able to deliver any individual colour on request. In addition to the existing standard and predefined colours, your desired product can on request be produced in any colour you choose.

- impact-resistant and abrasion-resistant housing finish thanks to environmentally friendly powder coating
- total corrosion protection for drawers thanks to electrophoretic dip painting



12 standard colours, 6 colour combinations

All colour-variable products are available in 12 standard colours and 6 colour combinations at no extra cost. The three-digit colour code (e.g. **.010**) forms part of the article number. When ordering, always complete the article number by adding the required colour code (e.g. **70.701.010**). Housings and drawers can also be ordered in different colours.

- | | | | | | |
|------------------------------------|---|--------------------------------------|-------------------------------------|---|------------------------------------|
| .010 Light blue
RAL 5012 | .020 Light grey
RAL 7035 | .030 Reseda green
RAL 6011 | .040 Capri blue
RAL 5019 | .050 Metallic grey
NCS S 6502-B | .060 Black
NCS S 9000-N |
| .070 Ruby red
RAL 3003 | .080 Pigeon grey
NCS S 4502-B | .090 Gentian blue
RAL 5010 | .100 Signal blue
RAL 5005 | .110 Pure white
RAL 9010 | .180 Grey white
RAL 9002 |
| .222 Galvanised version | | | | | |

An additional 12 predefined colours are available at extra cost

- | | | | | | |
|--|---|--|--|------------------------------------|---|
| .120 Grey aluminium
RAL 9007 | .130 White aluminium
RAL 9006 | .140 Light grey
NCS S 2000-N | .170 Ultramarine blue
RAL 5002 | .190 Sky blue
RAL 5015 | .200 Anthracite grey
RAL 7016 |
| .210 Brilliant blue
RAL 5007 | .220 Turquoise blue
RAL 5018 | .230 Pebble grey
RAL 7032 | .240 Flame red
RAL 3000 | .260 Slate grey
RAL 7015 | .280 Orange
RAL 2004 |

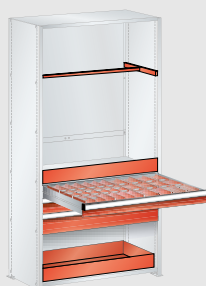
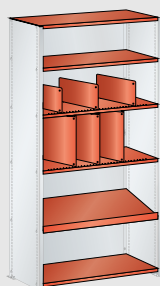

3. Shelves

- Choice of shelves (plain, slotted) and compartment load
- Optional: Stop bars for sloping shelves, shelf labelling, partitions and dividers

4. Accessories

- Optional: Choice of accessory shelf front cover strips, drawers, partition material, drip trays, clothes rails, Cover panels, etc.

5. Front-mounting fits

- Optional: Hinged and sliding doors

6. Add-on elements «Office»

- Optional: sideboard, side panel covers

Dimensions and load capacities

kg Max. load per unit 2,800 kg with a distance between shelves of max. 750 mm

kg Max. compartment load: 80, 160, 220, 280, 400 kg

Adjustment increment: 25 mm

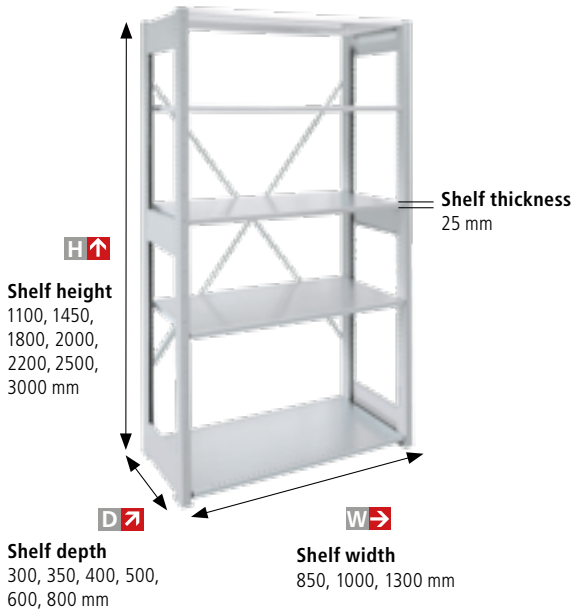

Planning instructions

Calculating the external dimensions

Overall width of shelving: Total shelving widths + number of supports × 40 mm + 10 mm (base plate external)

Overall depth of shelving: Shelf depth + 4 mm

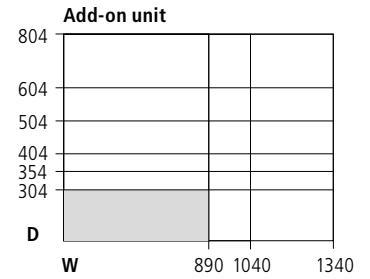
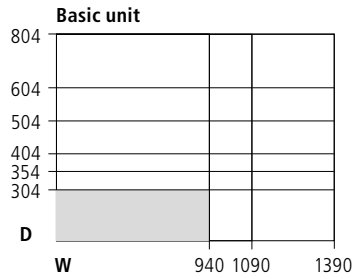

Safety instructions

Anchoring rule Units with a depth to height ratio greater than 1:5 (1:4 for units with hinged doors and single units with drawers) must be anchored. Floor anchoring: Art. no. **130.555.000** (each).

Arrangement of diagonal braces For each basic unit and for each third add-on unit, an extra diagonal brace is required. Instead of diagonal braces, rear panels can be used – or lengthwise braces in order to make the unit accessible from both sides. Diagonal brace: Art. no. **50.026.000**.

Basic and add-on shelf units

Basic unit

2 pairs of shelf supports incl.
6 horizontal braces
1 diagonal brace, galvanised
5-6 shelves, slotted (thickness 25 mm)

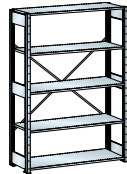

Add-on unit

1 pair of shelf supports, incl.
3 horizontal braces
5-6 shelves, slotted (thickness 25 mm)

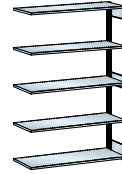

				D 400 mm		500 mm		600 mm	
H	W	Number of shelves	Shelf load kg	Basic unit Art. no.	Add-on unit Art. no.	Basic unit Art. no.	Add-on unit Art. no.	Basic unit Art. no.	Add-on unit Art. no.
2000	1000	5	160	50.200.XXX	50.201.XXX	50.202.XXX	50.203.XXX	50.204.XXX	50.205.XXX
			220	50.236.XXX	50.237.XXX	50.238.XXX	50.239.XXX	50.240.XXX	50.241.XXX
	1300	5	160	50.206.XXX	50.207.XXX	50.208.XXX	50.209.XXX	50.210.XXX	50.211.XXX
			220	50.242.XXX	50.243.XXX	50.244.XXX	50.245.XXX	50.246.XXX	50.247.XXX
2200	1000	5	160	50.212.XXX	50.213.XXX	50.214.XXX	50.215.XXX	50.216.XXX	50.217.XXX
			220	50.248.XXX	50.249.XXX	50.250.XXX	50.251.XXX	50.252.XXX	50.253.XXX
	1300	5	160	50.218.XXX	50.219.XXX	50.220.XXX	50.221.XXX	50.222.XXX	50.223.XXX
			220	50.254.XXX	50.255.XXX	50.256.XXX	50.257.XXX	50.258.XXX	50.259.XXX
2500	1000	6	160	50.224.XXX	50.225.XXX	50.226.XXX	50.227.XXX	50.228.XXX	50.229.XXX
			220	50.260.XXX	50.261.XXX	50.262.XXX	50.263.XXX	50.264.XXX	50.265.XXX
	1300	6	160	50.230.XXX	50.231.XXX	50.232.XXX	50.233.XXX	50.234.XXX	50.235.XXX
			220	50.272.XXX	50.273.XXX	50.280.XXX	50.281.XXX	50.288.XXX	50.289.XXX



Dimensions and load capacities

- Max. load per unit 1,000 kg
- Max. compartment load: 80, 160, 220, 280 kg
- Adjustment increment: 25 mm



Planning instructions

Calculating the external dimensions

- Overall width of shelving: Total shelf widths + 50 mm (base plate external)
- Overall depth of shelving: Shelf depth + 36 mm

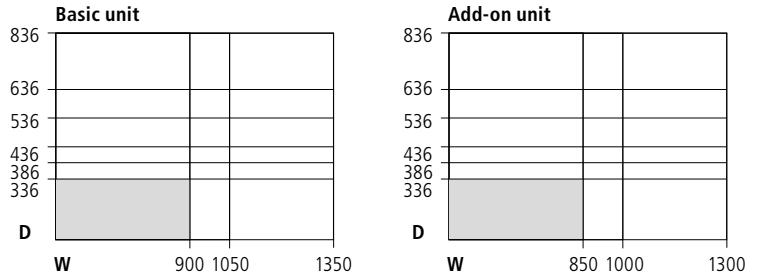

Max. base and extension section per shelving unit

Shelf spacing (mm)	150	300	450	600	max. 750
Permissible section load with diagonales or longitudinal connectors (kg)	max. 800	max. 770	max. 750	max. 710	max. 680
Permissible section load with rear panels (kg)	max. 1050	max. 1000	max. 950	max. 900	max. 850

! The load data apply only for uniformly distributed load! Please observe the safety instructions on pages 8.

Basic and add-on shelf units

Compartment load 80 or 160 kg, galvanised or painted

Basic unit
2 solid sheet side panels
1 diagonal brace, galvanised
4-7 shelves, plain (thickness 25 mm)

Add-on unit
1 solid sheet side panel
4-7 shelves, plain (thickness 25 mm)

Basic unit
2 solid sheet side panels
1 rear panel, plain (2-part)
4-7 shelves, plain (thickness 25 mm)

Add-on unit
1 solid sheet side panel
1 rear panel, plain (2-part)
4-7 shelves, plain (thickness 25 mm)

Basic unit
2 solid sheet side panels
1 rear panel, plain (2-part)
1 hinged door, lockable
6-7 shelves, plain (thickness 25 mm)

Add-on unit
1 solid sheet side panel
1 rear panel, plain (2-part)
1 hinged door, lockable
6-7 shelves, plain (thickness 25 mm)

Basic unit
2 solid sheet side panels
1 rear panel, plain (2-part)
7 drawers (3 x 100, 4 x 150 mm)
4 shelves, plain (thickness 25 mm)







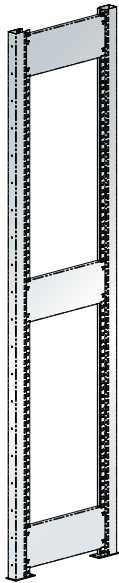

Add-on unit
1 solid sheet side panel
1 rear panel, plain (2-part)
7 drawers (3 x 100, 4 x 150 mm)
4 shelves, plain (thickness 25 mm)

	Number of shelves	1000 x 350 mm		1000 x 500 mm	
		Compartment load 80 kg		Compartment load 160 kg	
mm		Basic unit	Add-on unit	Basic unit	Add-on unit
1100	4	Art. no. 45.919.XXX	Art. no. 45.928.XXX	-	-
1450	5	Art. no. 45.922.XXX	Art. no. 45.931.XXX	-	-
1800	6	Art. no. 45.925.XXX	Art. no. 45.934.XXX	-	-
2000	6	Art. no. 50.300.XXX	Art. no. 50.301.XXX	Art. no. 50.302.XXX	Art. no. 50.303.XXX
2200	7	Art. no. 50.304.XXX	Art. no. 50.305.XXX	Art. no. 50.306.XXX	Art. no. 50.307.XXX
1100	4	Art. no. 45.955.XXX	Art. no. 45.964.XXX	-	-
1450	5	Art. no. 45.958.XXX	Art. no. 45.967.XXX	-	-
1800	6	Art. no. 45.961.XXX	Art. no. 45.970.XXX	-	-
2000	6	Art. no. 50.308.XXX	Art. no. 50.309.XXX	Art. no. 50.405.XXX	Art. no. 50.406.XXX
2200	7	Art. no. 50.407.XXX	Art. no. 50.408.XXX	Art. no. 50.409.XXX	Art. no. 50.410.XXX
2000	6	Art. no. 50.411.XXX	Art. no. 50.412.XXX	Art. no. 50.413.XXX	Art. no. 50.414.XXX
2200	7	Art. no. 50.415.XXX	Art. no. 50.416.XXX	Art. no. 50.417.XXX	Art. no. 50.418.XXX
2000	4	-	-	Art. no. 50.419.XXX	Art. no. 50.420.XXX
2200	4	-	-	Art. no. 50.421.XXX	Art. no. 50.422.XXX

1a. Pair of shelf supports Max. load per unit, 2,800 kg

Consisting of 2 shelf supports, 2 base plates and 3 horizontal braces. Slots 25 mm apart for attaching shelf supports at any height, including fastening material. Specification: Shelf supports in cold-rolled C profile, 40×75 mm, with 6 edge turns for maximum stability. Base plate, galvanised. Colour: As per colour chart or galvanised.



	300	350	400	500	600	800
	Art. no. 	Art. no. 	Art. no. 	Art. no. 	Art. no. 	Art. no. 
1100	45.680.XXX	45.681.XXX	45.682.XXX	–	–	–
1450	45.683.XXX	45.684.XXX	45.685.XXX	–	–	–
1800	45.686.XXX	45.687.XXX	45.688.XXX	45.689.XXX	45.690.XXX	45.691.XXX
2000	50.000.XXX	50.001.XXX	50.002.XXX	50.003.XXX	50.004.XXX	50.005.XXX
2200	50.516.XXX	50.517.XXX	50.518.XXX	50.519.XXX	50.520.XXX	50.521.XXX
2500	50.006.XXX	50.007.XXX	50.008.XXX	50.009.XXX	50.010.XXX	50.011.XXX
3000	45.692.XXX	45.693.XXX	45.694.XXX	45.695.XXX	45.696.XXX	45.697.XXX
Dimensions (W×D) mm	40×304	40×354	40×404	40×504	40×604	40×804

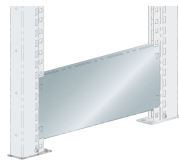

Additional horizontal braces

Specification: Steel sheet. Colour: As per colour chart or galvanised.

Art. no. 	Art. no. 	Art. no. 	Art. no. 	Art. no. 	Art. no. 
45.510.XXX	45.511.XXX	45.512.XXX	45.513.XXX	45.514.XXX	45.515.XXX

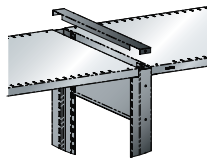

Shelf support cover

For covering the top of shelf supports. Specification: Steel sheet. Colour: As per colour chart or galvanised.

Art. no. 	Art. no. 	Art. no. 	Art. no. 	Art. no. 	Art. no. 
50.510.XXX	50.511.XXX	50.512.XXX	50.513.XXX	50.514.XXX	50.515.XXX



Intermediate fill-in strip

To close off intermediate spaces when shelves are at the same height. Not suitable for use with partitions. Description: sheet steel. Colour: according to colour chart or galvanised.

Art. no. 	Art. no. 	Art. no. 	Art. no. 	Art. no. 	Art. no. 
45.810.XXX	45.811.XXX	45.812.XXX	45.813.XXX	45.814.XXX	45.815.XXX

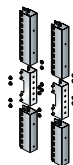

Extension unit, per pair of shelf supports

For shelving heights up to 5 m including fastening material. The static calculations for the extension will be carried out by LISTA's specialists. Specification: Galvanised.

Art. no.
50.484.000

 Levelling plates and floor anchoring on page 185.



1b. Solid sheet side panel Max. load per unit 1,000 kg

Standard with triangular folded reinforcing at the front. Slots 25 mm apart for attaching shelf supports. Including base plate set, galvanised. Specification: Steel sheet. Colour: As per colour chart or galvanised.



Side panel with T-edging for add-on units with rear panels.

		300	350	400	500	600	800
1100	Standard	Art. no. 45.607.XXX	Art. no. 45.608.XXX	Art. no. 45.609.XXX	–	–	–
	T-edging	45.637.XXX	45.638.XXX	45.639.XXX	–	–	–
1450	Standard	45.610.XXX	45.611.XXX	45.612.XXX	–	–	–
	T-edging	45.640.XXX	45.641.XXX	45.642.XXX	–	–	–
1800	Standard	45.613.XXX	45.614.XXX	45.615.XXX	–	–	–
	T-edging	45.643.XXX	45.644.XXX	45.645.XXX	–	–	–
2000	Standard	50.193.XXX	50.194.XXX	50.195.XXX	50.196.XXX	50.197.XXX	50.198.XXX
	T-edging	50.534.XXX	50.535.XXX	50.536.XXX	50.537.XXX	50.538.XXX	50.539.XXX
2200	Standard	50.522.XXX	50.523.XXX	50.524.XXX	50.525.XXX	50.526.XXX	50.527.XXX
	T-edging	50.540.XXX	50.541.XXX	50.542.XXX	50.543.XXX	50.544.XXX	50.545.XXX
2500	Standard	50.528.XXX	50.529.XXX	50.530.XXX	50.531.XXX	50.532.XXX	50.533.XXX
	T-edging	50.546.XXX	50.547.XXX	50.548.XXX	50.549.XXX	50.550.XXX	50.024.XXX
Dimensions (W × D) mm		30 × 336	30 × 386	30 × 436	30 × 536	30 × 636	30 × 836

NEW!
Shelf heights 1,100mm, 1,450mm and 1,800mm for 3, 4 or 5 file heights

Adapter side panel with T-edging for combining depth 350 with 500 mm including 2 shelf supports

	500	
2000	Art. no. 50.032.XXX	
2200	50.033.XXX	
2500	50.034.XXX	
Dimensions (W × D) mm		30 × 536

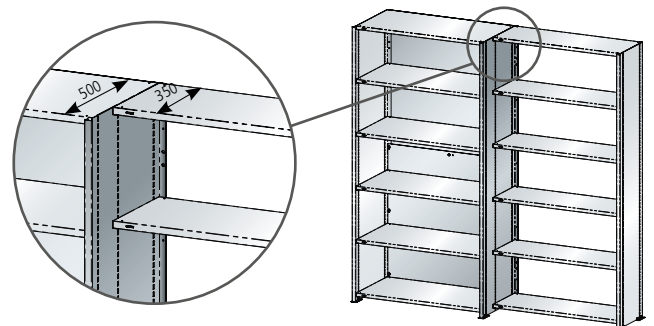

Shelf supports for additional shelves

For the adapter side panel with T-edge, special shelf supports are required if shelves at the same height are used next to one another. Two of these are required for each shelf.

Art. no. 45.739.000
10 pieces

Levelling plates, 50 × 100 mm

To compensate for height. Enable units to be aligned with precision on uneven floors. Specification: PVC. Colour: Grey.

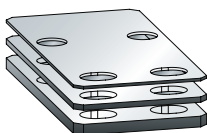

Art. no.	Thickness 1 mm	Thickness 2 mm	Thickness 4 mm
	50.481.000	50.482.000	50.483.000

Floor anchoring

Please follow the assembly instructions provided. For single shelf units, 2 per side panel or 2 per pair of shelf supports.

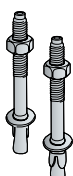

Floor anchor Art. no. 130.555.000
M8 × 75, each

Please observe the safety instructions on pages 182.



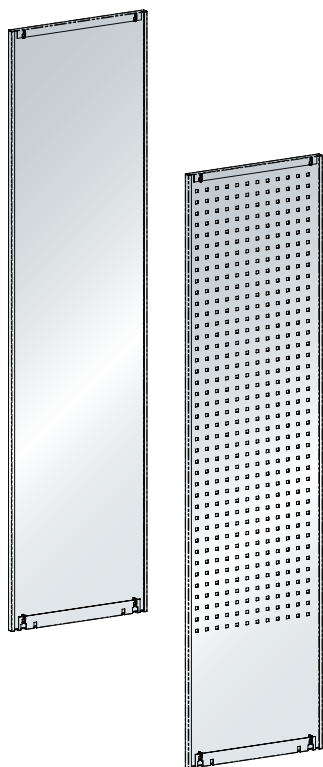

Side panel cover, plain or perforated

Add-on panel for covering the shelf supports or the rows of slots in the solid sheet side panels. Can be attached left or right. For perforated side panel cover: 10 × 10 mm square holes and 38 mm divisions for holding keyhole hooks (see page 117). Specification: Steel sheet, 2-part for height 3000 mm (1000 + 2000 mm). Colour: As per colour chart or galvanised.

		300	350	400	500	600	800
		Art. no.	Art. no.	Art. no.	Art. no.	Art. no.	Art. no.
1100	Plain	45.616.XXX	45.617.XXX	45.618.XXX	–	–	–
	Perforated	–	–	–	–	–	–
1450	Plain	45.619.XXX	45.620.XXX	45.621.XXX	–	–	–
	Perforated	–	–	–	–	–	–
1800	Plain	45.622.XXX	45.623.XXX	45.624.XXX	45.646.XXX	45.647.XXX	45.648.XXX
	Perforated	–	–	–	–	–	–
2000	Plain	50.012.XXX	50.013.XXX	50.014.XXX	50.015.XXX	50.016.XXX	50.017.XXX
	Perforated	50.337.XXX	50.338.XXX	50.339.XXX	50.340.XXX	50.341.XXX	50.342.XXX
2200	Plain	50.331.XXX	50.332.XXX	50.333.XXX	50.334.XXX	50.335.XXX	50.336.XXX
	Perforated	50.343.XXX	50.344.XXX	50.345.XXX	50.346.XXX	50.347.XXX	50.348.XXX
2500	Plain	50.018.XXX	50.019.XXX	50.020.XXX	50.021.XXX	50.022.XXX	50.023.XXX
	Perforated	50.349.XXX	50.350.XXX	50.351.XXX	50.352.XXX	50.353.XXX	50.354.XXX
3000	Plain	45.820.XXX	45.821.XXX	45.822.XXX	45.823.XXX	45.824.XXX	45.825.XXX
	Perforated	45.826.XXX	45.827.XXX	45.828.XXX	45.829.XXX	45.830.XXX	45.831.XXX
Dimensions (W) mm		21	21	21	21	21	21

Additional side panel covers, see page 19, add-on elements for office.

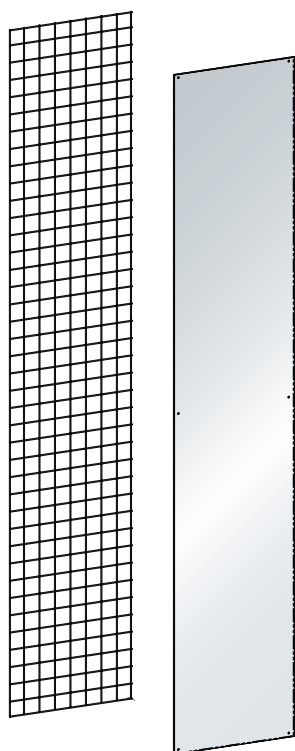

Grating cover, side panel cover or partition (plain) for shelf supports

Side panel grating cover: The gratings are clamped in place by the shelf supports and shelves. Can also be used as partition. Specification: Steel wire 3.0 mm, mesh size 50 × 50 mm, galvanised, blue chromated according to DIN 50961.

Partition (plain): Is placed between the shelf supports and held in place by the shelves. Specification: Steel sheet, 2-part for height 3000 mm (1000 + 2000 mm). Colour: As per colour chart or galvanised.

		300	350	400	500	600	800
		Art. no.	Art. no.	Art. no.	Art. no.	Art. no.	Art. no.
2000	Grating	50.387.000	50.388.000	50.389.000	50.390.000	50.391.000	50.392.000
	Plain	50.375.XXX	50.376.XXX	50.310.XXX	50.311.XXX	50.312.XXX	50.377.XXX
2200	Grating	50.393.000	50.394.000	50.395.000	50.396.000	50.397.000	50.398.000
	Plain	50.378.XXX	50.379.XXX	50.380.XXX	50.381.XXX	50.382.XXX	50.383.XXX
2500	Grating	50.399.000	50.400.000	50.401.000	50.402.000	50.403.000	50.404.000
	Plain	50.384.XXX	50.385.XXX	50.313.XXX	50.314.XXX	50.315.XXX	50.386.XXX
3000	Grating	45.832.000	45.833.000	45.834.000	45.835.000	45.836.000	45.837.000
	Plain	45.838.XXX	45.839.XXX	45.840.XXX	45.841.XXX	45.842.XXX	45.843.XXX
Dimensions (W) mm		3	3	3	3	3	3

Base covers

Protects against dust and dirt. The base covers rest on the base plates and are hooked into the shelf supports or side panels by shelf supports. Including fastening material.

Specification: Steel sheet.
Colour: Black.

		850	1000	1300
		Art. no.	Art. no.	Art. no.
25 mm		50.432.060	50.433.060	50.434.060



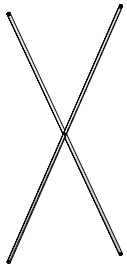

2 Diagonal brace

For stabilising the shelving units lengthwise. Fastening material included. Specification: Steel, galvanised.

Diagonal brace arrangement:

For each basic unit and for every third add-on unit, an extra diagonal brace is required.

Diagonal brace	Art. no.
for height 1100–1450 mm	45.655.000
for height 1800–2500 mm	50.026.000
for height 3000 mm	45.844.000

or...

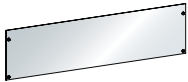

Lengthwise braces

Instead of diagonal braces, lengthwise braces (at the top and bottom) can be used in order to make the unit accessible from both sides.

Including fastening material.

Specification: Steel sheet.

Colour: As per colour chart or galvanised.

or...

Rear panels, plain or perforated

The rear panel cover for shelving sections also stabilises the units lengthwise and is screwed to the shelf supports or side panels.

For perforated rear panel: Specification: 10 × 10 mm square holes and 38 mm divisions for holding keyhole hooks.

Including fastening material. Specification: 2-part, sheet steel.

Colour: As per colour chart or galvanised.

Rear grating

Rear grating filling for shelf units. The rear gratings are screwed to the shelf supports or side panels. Including fastening material. Specification: Steel wire 3.0 mm.

Mesh size 50 × 50 mm, galvanised, blue chromated according to DIN 50961.

! To stabilise the shelving systems lengthwise, diagonal or lengthwise braces must be used in addition to the perforated rear panel.

! **Rear panel link piece** is absolutely essential for all rear panels used in combination with shelf supports. Basic unit: 2 × width 80 mm and for each add-on unit 1 × width 120 mm. Specification: Steel sheet. Colour: As per colour chart or galvanised.



W →	850	1000	1300
version	Art. no.	Art. no.	Art. no.
For shelf supports, per pair, height 185 mm	50.319.XXX	50.320.XXX	50.321.XXX
For solid sheet side panel, per pair, height 185 mm	50.322.XXX	50.323.XXX	50.324.XXX

W →	850	1000	1300
H ↑	Art. no.	Art. no.	Art. no.
1100 Plain	45.600.XXX	45.601.XXX	-
1450 Plain	45.602.XXX	45.603.XXX	-
1800 Plain	45.604.XXX	45.605.XXX	45.606.XXX
Plain	50.355.XXX	50.027.XXX	50.029.XXX
2000 Perforated	50.360.XXX	50.361.XXX	50.362.XXX
Grating	50.423.000	50.424.000	50.425.000
Plain	50.356.XXX	50.357.XXX	50.358.XXX
2200 Perforated	50.363.XXX	50.364.XXX	50.365.XXX
Grating	50.426.000	50.427.000	50.428.000
Plain	50.359.XXX	50.028.XXX	50.030.XXX
2500 Perforated	50.366.XXX	50.367.XXX	50.368.XXX
Grating	50.429.000	50.430.000	50.431.000
Plain	45.845.XXX	45.846.XXX	45.847.XXX
3000 Perforated	45.848.XXX	45.849.XXX	45.850.XXX
Grating	45.851.000	45.852.000	45.853.000

W →	80	120
H ↑	Art. no.	Art. no.
1100	45.649.XXX	45.650.XXX
1450	45.651.XXX	45.652.XXX
1800	45.653.XXX	45.654.XXX
2000	50.369.XXX	50.370.XXX
2200	50.371.XXX	50.372.XXX
2500	50.373.XXX	50.374.XXX
3000	45.854.XXX	45.855.XXX









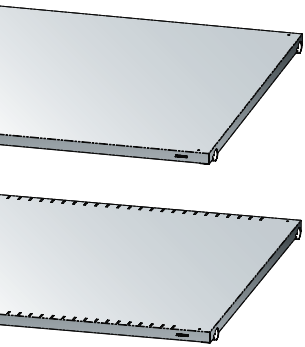

Universal shelving L1006 | single components

3 Shelves, plain or slotted Max. compartment load 80, 160, 220, 280 and 400 kg





Including floor anchor. Shelf thickness 25 mm. Specification: Steel sheet. Colour: As per colour chart or galvanised.



			300	350	400	500	600	800
	Shelf load 	Art. no. 	Art. no. 	Art. no. 	Art. no. 	Art. no. 	Art. no. 	
850	80	Plain	50.035.XXX	50.036.XXX	50.038.XXX	-	-	-
		Slotted	50.080.XXX	50.081.XXX	50.083.XXX			
	160	Plain	55.737.XXX	50.037.XXX	50.039.XXX	50.041.XXX	50.044.XXX	50.047.XXX
		Slotted	55.738.XXX	50.082.XXX	50.084.XXX	50.086.XXX	50.089.XXX	50.092.XXX
	220	Plain	-	-	50.040.XXX	50.042.XXX	50.045.XXX	50.048.XXX
		Slotted			50.085.XXX	50.087.XXX	50.090.XXX	50.096.XXX
280	Plain	-	-	-	50.043.XXX	50.046.XXX	50.049.XXX	
	Slotted				50.088.XXX	50.091.XXX	50.097.XXX	
1000	80	Plain	50.050.XXX	50.051.XXX	50.053.XXX	-	-	-
		Slotted	50.098.XXX	50.164.XXX	50.166.XXX			
	160	Plain	55.739.XXX	50.052.XXX	50.054.XXX	50.056.XXX	50.059.XXX	50.062.XXX
		Slotted	55.741.XXX	50.165.XXX	50.167.XXX	50.169.XXX	50.172.XXX	50.175.XXX
	220	Plain	-	-	50.055.XXX	50.057.XXX	50.060.XXX	50.063.XXX
		Slotted			50.168.XXX	50.170.XXX	50.173.XXX	50.176.XXX
280	Plain	-	-	-	50.058.XXX	50.061.XXX	50.064.XXX	
	Slotted				50.171.XXX	50.174.XXX	50.177.XXX	
1300	400	Plain	-	-	-	45.550.XXX	45.551.XXX	45.552.XXX
		Slotted				45.556.XXX	45.557.XXX	45.558.XXX
	80	Plain	50.065.XXX	50.066.XXX	50.068.XXX	-	-	-
		Slotted	50.178.XXX	50.179.XXX	50.181.XXX			
	160	Plain	55.746.XXX	50.067.XXX	50.069.XXX	50.071.XXX	50.074.XXX	50.077.XXX
		Slotted	55.747.XXX	50.180.XXX	50.182.XXX	50.184.XXX	50.187.XXX	50.190.XXX
220	Plain	-	-	50.070.XXX	50.072.XXX	50.075.XXX	50.078.XXX	
	Slotted			50.183.XXX	50.185.XXX	50.188.XXX	50.191.XXX	
280	Plain	-	-	-	50.073.XXX	50.076.XXX	50.079.XXX	
	Slotted				50.186.XXX	50.189.XXX	50.192.XXX	

Additional strengtheners

For subsequently increasing the compartment load. The strengtheners are snapped into the side edgings of the shelves. Specification: Steel sheet. Colour: As per colour chart or galvanised.

	850	1000	1300
Art. no. 	Art. no. 	Art. no. 	
50.438.XXX	50.439.XXX	50.440.XXX	

 **Depth 350 mm:** Max. 1 strengthener
Depth 400 mm: Max. 2 strengtheners
Depth 500 mm: At least 1 strengthener and max. 3 strengtheners



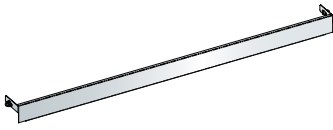

Stop bars for sloping shelves

The stop bars can be screwed front and back to the shelf supports or side panels. The shelves and stop bars can also be slotted in at an angle. Ideal for making material and parts available according to the FIFO principle. Specification: Steel sheet. Colour: As per colour chart or galvanised.

W →	850	1000	1300
	Art. no.	Art. no.	Art. no.
for 3a	50.316.XXX	50.317.XXX	50.318.XXX

Max. angle of inclination of the shelves:

Depth 300 = 33°, 350 = 29°, 400 = 28°, 500 = 25°, 600 = 23°, 800 = 20°



Shelf labelling

Self-adhesive plastic label strips with hinged transparent protector, including labels. Width × height, 210 × 22 mm.

Sales units	Art. no.
10 pieces	18.931.000

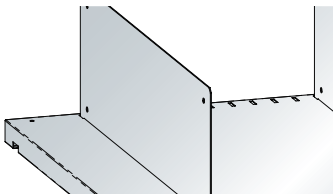

Dividers

For subdividing slotted shelves. Specification: Steel sheet. Colour: As per colour chart or galvanised. Sales unit: 10 pcs.

D ↗	300	350	400	500	600	800
H ↑	Art. no.	Art. no.	Art. no.	Art. no.	Art. no.	Art. no.
100	50.103.XXX	50.106.XXX	50.109.XXX	50.112.XXX	50.115.XXX	50.118.XXX
150	50.104.XXX	50.107.XXX	50.110.XXX	50.113.XXX	50.116.XXX	50.119.XXX
200	50.105.XXX	50.108.XXX	50.111.XXX	50.114.XXX	50.117.XXX	50.120.XXX

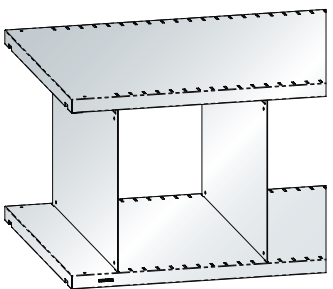

Shelf dividers

For subdividing slotted shelves. The height of the shelf dividers, slotted in at the top and the bottom, depends on the distance between the shelves. Clear shelf spacing = shelf divider height. Specification: Steel sheet. Colour: As per colour chart or galvanised. Sales unit: 10 pcs.

D ↗	300	350	400	500	600	800
H ↑	Art. no.	Art. no.	Art. no.	Art. no.	Art. no.	Art. no.
250	50.121.XXX	50.126.XXX	50.131.XXX	50.136.XXX	50.141.XXX	50.146.XXX
300	50.122.XXX	50.127.XXX	50.132.XXX	50.137.XXX	50.142.XXX	50.147.XXX
325	50.123.XXX	50.128.XXX	50.133.XXX	50.138.XXX	50.143.XXX	50.148.XXX
350	50.124.XXX	50.129.XXX	50.134.XXX	50.139.XXX	50.144.XXX	50.149.XXX
400	50.125.XXX	50.130.XXX	50.135.XXX	50.140.XXX	50.145.XXX	50.150.XXX



Universal shelving L1006 | single components

4. Shelf front cover strip

For storing bulk goods and small parts. Is screwed to the shelf supports or side panels. Including fastening material.
Specification: Steel sheet. Colour: As per colour chart or galvanised.



H ↑
75

W →	850	1000	1300
	Art. no.	Art. no.	Art. no.
	50.435.XXX	50.436.XXX	50.437.XXX

Drawers

Smooth-running drawers with full extension for ideal storage of small parts and tools. Load capacity 50 kg.
Specification: Steel sheet. Colour: As per colour chart, **not available in galvanised version.**

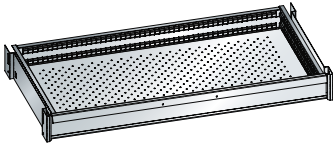

H ↑
75

W → D ↗	1000 × 350	1000 × 500
	Art. no.	Art. no.
	55.165.XXX	55.172.XXX
	55.166.XXX	55.173.XXX
	55.167.XXX	55.174.XXX
LISTA units	54 × 18 E	54 × 27 E
Useable drawer size (W × D mm)	918 × 306	918 × 459

100

150

LISTA units

Useable drawer size (W × D mm)



Drip trays

Can be placed loose on the shelves with a shelf width of 1,000 mm. Can also be removed if hinged doors are used.
Specification: Height 100 mm, chromium steel. Material thickness: 2 mm. Welded liquid-tight. Designed according to Section 19 WHG (German Water Resources Act) / StawaR (German directive on steel trays).
The drip tray is leak-tested and has a data plate to that effect as well as a test certificate.

W →	D ↗	300	350	400	500	600	800
		Art. no.	Art. no.	Art. no.	Art. no.	Art. no.	Art. no.
1000		53.823.000	53.828.000	53.824.000	53.825.000	53.826.000	53.827.000
Capacity in litres		26	32	36	45	54	72

Pull-out suspension filing frame

Suitable for A4 suspension files. Max. load capacity 50 kg. Specification: Steel sheet. Colour: As per colour chart, **not available in galvanised version.**

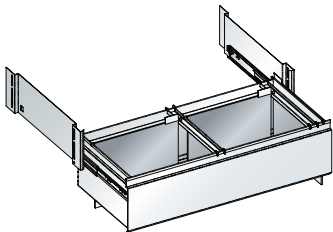

W →	850	1000	1300
D ↗	Art. no.	Art. no.	Art. no.
350	50.441.XXX	50.444.XXX	50.446.XXX
400	50.442.XXX	50.445.XXX	50.447.XXX
500	50.443.XXX	50.156.XXX	50.448.XXX



Lateral profiles

C700.16 for storage system: Vetro lateral file A4 landscape (985 × 450 A4 lateral and folio)

C700.17 for storage system: Datox EDP files, Monopendex files, ELBA centre point suspension files 91460, Leitz suspension files, Eichner suspension files. Specification: Steel sheet. Colour: Grey, NCS S 2502-R. Including fastening material.

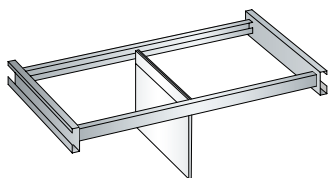

D ↗	W →	850	1000	1300
version		Art. no.	Art. no.	Art. no.
350	C700.16	35.143.000	32.559.000	50.154.000
	C700.17	35.149.000	32.581.000	50.157.000
500	C700.16	35.147.000	32.578.000	50.155.000
	C700.17	35.153.000	32.599.000	50.158.000

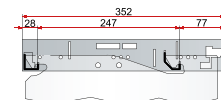

C700.16

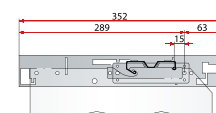

C700.17





Centre partition

For vertically subdividing complete shelf units with a depth of 500 mm. The centre divider is fixed in place by the shelves. Width 30 mm. Height of centre divider = shelf unit height - 25 mm. Specification: Steel sheet. Colour: As per colour chart or galvanised.

	H ↑	2000	2200	2500
D ↗		Art. no.	Art. no.	Art. no.
500		50.328.XXX	50.329.XXX	50.330.XXX

! Select the top shelf so that it fits over the entire width of the shelving unit. Further assembly of the shelving units takes place with shelves for the centre partition.

Plain shelves, smooth, for centre divider

Including floor anchor. Shelf thickness 25 mm. Unit load 80 kg. Specification: Steel sheet. Colour: As per colour chart or galvanised.

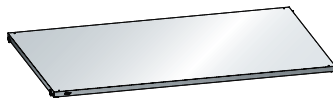

	W →	425	500	650
D ↗		Art. no.	Art. no.	Art. no.
500		50.325.XXX	50.326.XXX	50.327.XXX

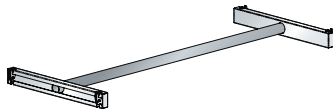

Clothes rail for centre divider

The clothes rails are fitted by means of crossbar plates and shelf supports. Specification: Rail made of anodised aluminium, Ø 27 mm, crossbars in sheet steel. Load capacity 50 kg. Colour of the crossbars: As per colour chart or galvanised.

	W →	425	500	650
D ↗		Art. no.	Art. no.	Art. no.
500		50.495.XXX	50.496.XXX	50.497.XXX

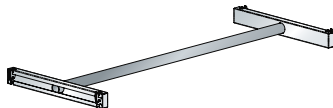

Clothes rail

The clothes rails are fitted by means of crossbar plates and shelf supports. Specification: Rail made of anodised aluminium, Ø 27 mm, crossbars in sheet steel. Load capacity 50 kg. Colour of the crossbars: As per colour chart or galvanised.

	W →	850	1000	1300
D ↗		Art. no.	Art. no.	Art. no.
400		50.498.XXX	50.502.XXX	50.506.XXX
500		50.499.XXX	50.503.XXX	50.507.XXX
600		50.500.XXX	50.504.XXX	50.508.XXX
800		50.501.XXX	50.505.XXX	50.509.XXX

Organising rail

For vertical storage, compartment division and for storing various materials in rings (cables, vee belts and tubing). The crossbars are screwed to the shelf supports or side panels. Load capacity 50 kg. The brackets are screwed to the crossbar. Including fastening material. Specification: Steel sheet. Colour: As per colour chart, **not available in galvanised version**.

Crossbars

	W →	850	1000	1300
		Art. no.	Art. no.	Art. no.
		50.486.XXX	50.487.XXX	50.488.XXX

Brackets

	D ↗	300	350	400	500	600	800
		Art. no.	Art. no.	Art. no.	Art. no.	Art. no.	Art. no.
		50.489.XXX	50.490.XXX	50.491.XXX	50.492.XXX	50.493.XXX	50.494.XXX

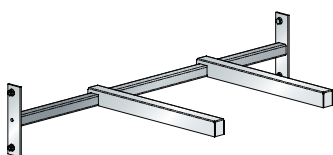

5 Hinged doors

Hinged with a 2-point bar lock with a recess for a clasp lock (must be ordered separately). The hinged doors can also be retrofitted to all shelf units. Specification: Steel sheet. Colour: As per colour chart, **not available in galvanised version**.
Shelving depth with hinged door = shelving depth side panel/pair of shelf supports +30 mm



H ↑	Shelf supports			Side panel		
	W → 850	1000	1300	850	1000	1300
1100	Art. no. -	Art. no. -	Art. no. -	Art. no. 45.631.XXX	Art. no. 45.632.XXX	Art. no. -
1450	-	-	-	45.633.XXX	45.634.XXX	-
1800	-	-	-	45.635.XXX	45.636.XXX	-
2000	50.472.XXX	50.473.XXX	50.474.XXX	50.467.XXX	50.160.XXX	50.162.XXX
2200	50.475.XXX	50.476.XXX	50.477.XXX	50.468.XXX	50.469.XXX	50.470.XXX
2500	50.478.XXX	50.479.XXX	50.480.XXX	50.471.XXX	50.161.XXX	50.163.XXX



Cover profile with supports

Basic unit: 2 x cover profile and for each add-on unit 1 x cover profile. Specification: sheet steel. Colour: As per colour chart, **not available in galvanised version**.

H ↑	2000	2200	2500
Art. no.	45.740.XXX	45.741.XXX	45.742.XXX

! Cover profile for hinged doors is absolutely essential for all hinged doors used in combination with shelf supports.

+ clasp lock

KEY Lock, separately lockable	49.060.000
CODE Lock	49.085.000
RFID Lock	49.086.000



+ clasp lock cover (optional)

Rear clasp lock cover for a more attractive appearance. **45.864.XXX**
 Specification: sheet steel. Colour: As per colour chart.

Sliding doors

Two shelving sections are closed with each sliding door. Running smoothly and quietly on castors: In a runner and guide rail which are fastened to the shelf supports at the bottom and/or at the top. Lockable with a lock-down cylinder lock. The lock must be ordered separately. The doors can be opened wide enough for one entire shelving unit to be freely accessible. The sliding doors can also be fitted later. Specification: Steel sheet. Colour: As per colour chart, **not available in galvanised version**.
Shelving depth with hinged door = shelving depth side panel/pair of shelf supports +105 mm



H ↑	Shelf supports			Side panel		
	W → 2 x 850	2 x 1000	2 x 1300	2 x 850	2 x 1000	2 x 1300
2000	Art. no. 50.458.XXX	Art. no. 50.459.XXX	Art. no. 50.460.XXX	Art. no. 50.449.XXX	Art. no. 50.450.XXX	Art. no. 50.451.XXX
2200	50.461.XXX	50.462.XXX	50.463.XXX	50.452.XXX	50.453.XXX	50.454.XXX
2500	50.464.XXX	50.465.XXX	50.466.XXX	50.455.XXX	50.456.XXX	50.457.XXX

+ lock-down cylinder lock

KEY Lock, separately lockable	55.438.000
-------------------------------	------------



6 Add-on elements for «Office»

Sideboard

Equipment: with optional multiplex or resin cover panel. The cover panels can be attached with mountable fastening brackets. Includes predrilled holes and fastening material. Side panels, side panel covers (right and left) for covering the rows of slots and for flush closure with the front triangular edging, rear panel cover for shelving units and lengthwise stability. Description: sheet steel. Colour: according to colour chart or galvanised.

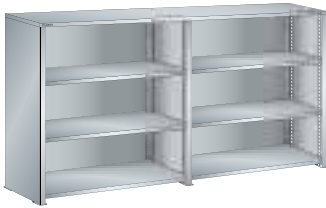

				W →		1000	2 × 1000
D ↗	H ↑	Number shelves	Shelf load (kg)		Art. no.	Art. no.	
350	1100	3	80	Multiplex	45.975.XXX	45.976.XXX	
				Resin	45.977.XXX	45.978.XXX	
	1450	4	80	Multiplex	45.979.XXX	45.980.XXX	
				Resin	45.981.XXX	45.982.XXX	
400	1100	3	80	Multiplex	45.983.XXX	45.984.XXX	
				Resin	45.985.XXX	45.986.XXX	
	1450	4	80	Multiplex	45.987.XXX	45.988.XXX	
				Resin	45.989.XXX	45.990.XXX	

Cover panel, resin-coated, thickness 22 mm

Surface and edging light grey, NCS S 1500-N, laminated chipboard (quality class E1), with melamine coating on both sides (manufactured according to standard EN 14322). 2 mm thick plastic edging on all sides. Including double-sided adhesive tape.



Multiplex cover panel, thickness 30 mm

Made of steamed beech veneers, glued in multiple layers and waterproof (DIN 68 705), bevelled edges, sanded, oiled and waxed surface. The panel is splash-proof, dirt-repellent and largely impervious to oil and grease. Including double-sided adhesive tape.

Side panel covers

Filler panels (left and right) for covering the rows of slots in the side panels and for flush closure with the front triangular edging of the side panels. For left and right mounting. Description: width 21 mm, sheet steel. Colour: according to colour chart or galvanised.



		H ↑		1100	1450	1800	2000
D ↗	Description	Art. no.	Art. no.	Art. no.	Art. no.	Art. no.	Art. no.
350	Per pair	45.890.XXX	45.891.XXX	45.892.XXX	45.893.XXX	45.894.XXX	45.895.XXX
400	Per pair	45.894.XXX	45.895.XXX	45.896.XXX	45.897.XXX	45.898.XXX	45.899.XXX



